

## CLOCK TOWERS FROM THE OTTOMAN PERIOD IN THE TERRITORY OF TODAY'S MONTENEGRO

Rifat ALIHODŽIĆ\*

Received: 01.04.2018; Final Text: 30.09.2019

**Keywords:** Clock towers; Montenegro;  
Ottoman period; cultural heritage; urban  
landmarks.

### INTRODUCTION

Time measurement dates back to 3000-2000 BCE in Mesopotamia and Egypt. Sun-light, water, oil or sand were used to measure time (Acun, 2011, 3). Sundials indicated a position of the shadow on the dial, sandglasses measured the time of sand trickling through a glass-bulb, while water clocks indicated the time of water pouring down from one container to another.

First measurements of time by mechanical means, as a precursor of mechanical clocks' production in Europe, were performed by monks. In certain time intervals, mechanism would produce a sound by hitting bells, functioning as alarm-clocks, without hands or dials. They appeared in the 13<sup>th</sup> century in Westminster, England and Padua, Italy (Borstin, 1983, 39-42). Two types of alarm-clocks were manufactured: room alarm-clocks called *horologia excitatoria* and another type, serving to wake a chief monk, called *custosa horologii*. He would inform the others by pulling the tower's great bell. Soon the production began of greater clockwork-mechanisms to be placed on towers near churches, designed to automatically hit bells.

Mechanical clocks imposed a new sense to humans: the time human mind had been used to, was turned into a sum of time units, which greatly differed from the impression of smooth flowing of sun rays, water or sand. Upon appearance of clockwork-mechanisms with dials, clock towers started arising not only near churches but on important public spaces, as well. They would draw attention even to those who had no particular reason to measure time in hours. With such positioning, they served the whole community, providing citizens with otherwise unaffordable information.

Unlike other western innovations that were intensely followed, clock towers with mechanical clocks appeared in the Ottoman Empire about 200 years later than in Europe. The traveller Hans Dernschwam visited

\* University of Montenegro, Faculty of  
Architecture, Podgorica, MONTENEGRO.

the Ottoman Empire between 1553 and 1555. He recorded not having seen church-bells or clockwork-mechanisms around. Ogier Ghiselin de Busbecq, Ambassador to Ferdinand I, visited Sultan Sulejman on 1<sup>st</sup> June 1560. He was wondered, he noted, not to see any clock tower around despite their wide presence in the west, although Ottomans were fast to adopt other European inventions (Acun, 2011, 2-35).

First written data on mechanical clocks in the Ottoman Empire may be found in the works: "*Alat-ı Rasadiye*", "*Li Zic - i Şehinşahiye*", "*Sidret ül - Münteha ve Mekanik Saat Konstrüksiyonuna Dair En Parlak Yıldızlardır*", by Takiyuddin Hassan (1526-1585). During the reign of Murat III (1574-1595), one of the best observatories of that time was founded. In "*Alat - ı Rasadiye'de*". Takiyuddin noted that among 9 instruments there was also a clock (Acun, 2011, 4-5).

In the Ottoman Empire, construction of clock towers was spreading from west to east, so these buildings started arising in the 16<sup>th</sup> century. In 1571, Karl Rym referred to a clock tower in Osijek (Croatia), which, therefore, may be considered the first clock tower in the Ottoman Empire (Karač and Žunić, 2018, 77). A clock tower was also built in Banja Luka (Bosnia-Herzegovina), near Ferhat-Pasha's Mosque in 1577 (Acun, 2011, 4).

Unlike churches in the west, where clockwork-mechanisms were often placed at church towers, in the Ottoman Empire clockwork-mechanisms were not built into minarets. Instead, separate buildings-towers were built near important mosques, in commercial city-districts, on natural elevations, or, more rarely, on top of some buildings. The intention was, similar to Europe, to make clock towers easily visible from various city spots.

In the Ottoman period, clock towers mostly had a square plan. They entailed three parts to be distinguished vertically: the stone base, the body of the tower (containing the staircase) and the last part, where a clockwork-mechanism and a bell were installed. Staircases were built either in "Z"-shape or spirally. Roofs were mostly four-vaulted and often dome-shaped on the inside in order to provide for better acoustic effects. Clockwork-mechanism played a double role: triggering the hammer to beat at one bell only and moving the clock's hands. There were 1 to 4 dials placed on the façades. In the beginning, but at later stages, too, clockwork-mechanisms, setting off the bell, but without dials, were in use to reduce the costs. At first, clockwork-mechanisms used to show the time in line with Hijri – lunar Calendar called "*a la Turca*". A day between the two sunsets was divided in 12-hour intervals, so that it lasted 24 hours. A more significant opening of the Ottoman Empire towards Europe was intensified at the beginning of the 19<sup>th</sup> century, when the western system of time measurement "*a la Franca*" became ever more present. In line with this system (Gregorian calendar), a day starts at 12 o'clock in the night and it lasts 24 hours. To avoid a possible confusion, it was ordered that, among the military, civilian circles and in vilayets, "*a la Franca*"-system should be used (Acun, 2011, 8).

## CLOCK TOWERS IN MONTENEGRO

Clock towers that are subject to this research have not so far been comprehensively analysed. The research showed that only four authors dealt with these buildings in the territory of Montenegro. Bajro Agović (2015), despite using authentic, accurate sources, presented clock towers in Montenegro in a rather descriptive manner. However, there are some

debatable assertions in his work, since he attributed the construction of Herceg-Novi clock tower entirely to the Ottoman period. This fact had previously been clarified by Zorica Čubrović (2009) in an argumentative manner. Igbala Šabović-Kerović (2015) analysed, inter alia, Ulcinj clock tower. In a comprehensive monography, dedicated to the Ottoman Empire clock towers, Hakkı Acun (2011) mapped and described two clock towers in Montenegro: in Podgorica and in Bar. Acun underlined that scientific community was for the first time presented with the Ottoman Empire clock towers, adding that he had not had the chance to see some clock towers in Palestine, Iraq, Israel or Montenegro. He stated that his book was the first collective source on the Ottoman Empire clock towers. Consequently, this study complements Acun's research mosaic with three additional clock towers: those in Pljevlja, Ulcinj and Herceg-Novi.

### Context in which the Clock Towers were Built

Montenegro (Karadağ) fell under rule of the Ottoman Empire in 1496. It was annexed to the Sanjak of Scutari (İskenderiye Sancağı) as a separate district (Stanojević, 1976, 12). Its dominant settlements with fortifications were: Podgorica, Medun, Žabljak, Herceg Novi, Risan, Bar and Ulcinj. Montenegro gained its statehood, over a smaller territory than the today's, at Berlin Congress in 1878. Last Ottoman Empire territories were annexed to Montenegro in 1912. Montenegro was constituted within its present-day borders in 1945, after World War II. Its territory occupies a relatively-small geographical space of 13.812 km<sup>2</sup>, with a population of 625.266 inhabitants, according to the 2001 census (Statistical Office of Montenegro, 2011, 15).

The Ottoman Empire intensified urbanisation and construction in the newly-conquered areas of Montenegro, introducing a new construction style which became symbiotic with the local ways of constructing and the applied materials. Urbanisation of cities entailed fortresses, military infrastructure, commercial-administrative districts with religious and other buildings (*çarşı*), as well as residential neighbourhoods (*mahalle*). According to their size and importance, cities were divided in two categories: *kasaba* and *şehir*. None of the cities in Montenegro had ever reached the status of a *şehir*. Particular contribution to the living culture was made not only through introducing inner courtyards (*avlu*) and specific spatial organisation, but also the cult of water, by use of bathrooms within residential spaces (*hamam*). The fortified cities (Ulcinj, Bar, Herceg Novi, Žabljak Crnojevića) were further reinforced by Ottomans, who provided their own engineering experiences. Some new fortifications were also built, such as Podgorica and Nikšić. Among religious buildings, the most famous is Hussein-Pasha's Mosque in Pljevlja, a semi-dome building, still in function today (Kujović, 2006, 25). In Montenegro, a total of 222 buildings from the Ottoman period have been identified, out of which 95 (43%) were preserved, more than in all the other Balkan countries together with the exception of Kosovo, where 61% of buildings from that period were preserved (Ibrahimgil and Keleş, 2018, 2). The endowment (*waqf*), embedded in Sharia law, was particularly important for the development of urban areas in the Ottoman Empire. This model contributed to constructing some of the most significant buildings in the Montenegrin part of the Empire (Miljković, 2019, 62).

In Montenegro's territory there are five clock towers dating from the Ottoman period, situated in Pljevlja, Bar, Ulcinj, Podgorica and Herceg-Novi (**Figure 1**). Existence of clock towers in these cities demonstrates

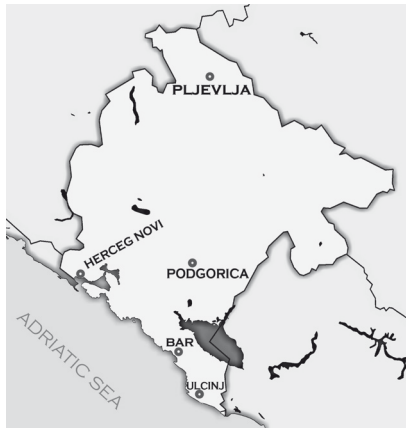

**Figure 1.** Locations of Ottoman-period clock towers in today's Montenegro (Drawing by R. Alihodžić, 2018).



**Figure 2.** Nine Mosques of Pljevlja in 1902: 1. Hussein Pasha's Mosque with a clock tower; 2. Haji Hassan Mosque (destroyed); 3. Rizvan-Chaush Mosque; 4. Bubica Mosque, destroyed in 1959; 5. Misri Ahmed-Bay Jusuf Kadi Mosque, destroyed in 1959; 6. Haji Zakariya Mosque; 7. OdoBASHA's Mosque, destroyed in 1936; 8. Haji Aliya Mosque; 9. Hamidiya Mosque, destroyed in 1940; (Photo from the Pljevlja Heritage Museum).

their significance, as clock towers were built only in urban centres of major importance, thus also representing a specific status symbol.

Pljevlja became part of the Ottoman Empire in 1465 as a developed urban centre, known under Turkish name *Taşlıca* (Vasić, 1975, 503-58). It lived its intense urban development in the 1560s, during the rule of Hussein-Pasha Boljanić, who was twice the Beylerbeyi of Bosnian Beylerbeylik (1569-1572, 1594-1595). Pljevlja was the seat of the Sanjak of Herzegovina (Hersek Sancağı) in 1576-1833. Beside its principal building - the semi-dome Hussein-Pasha's Mosque, the endowment of Hussein-Pasha Boljanić, a central market, medresas, maktabs, a karvansaray and a public bath were also built in this city under his patronage. It is widely known that he endowed the city with 19 buildings (Ibrahimgil and Keleş, 2018, 12). The clock tower, built next to the Hussein-Pasha's Mosque, dates from the 16<sup>th</sup> century, as well.

Pljevlja was an open city, with no fortress. In its heyday, it entailed nine residential neighbourhoods (mahalles) and a central market (çarşı) (Prekić, 2019, 129). In 1879, following Berlin Congress, Austro-Hungarian army came to Pljevlja and formed a military garrison. It abandoned the city in 1908, so that Ottomans regained authority over it. Montenegro and Serbia took over the city in 1912. Pljevlja became an integral part of present-day Montenegro in 1913, by agreement between the Kingdom of Serbia and the Kingdom of Montenegro (Petrovic, 2014, 279). Until the 20<sup>th</sup> century, Pljevlja had nine mosques (Figure 2), four existing today, the rest being destroyed (Agović, 2015, 259-63). Hussein-Pasha's Mosque with the clock tower, as well as other mosques and the remains of Ottoman-style residential architecture still significantly determine the cityscape (Figure 3).

In 1571, Ottomans seized the fortified city of Bar from the Venetian Republic. It was the only fortified city at the Montenegrin seaside without direct access to the sea. In 1867, Bar got under administration of the Sanjak of Scutari, later to become Scutari Vilayet (İşkodra Vilayeti) (Ivanović, 2013, 15). Beside the comprehensive military infrastructure, the city also had a civilian part where important officials resided (Figure 4). During the years 1698, 1710, 1732, 1770 and 1859, significant changes and reparations of Venetian fortifications were made in line with the dominant Ottoman-style architecture of that era. Among significant civilian buildings within the fortress, there is nowadays a public bath (hamam) and two destroyed mosques: Sultan Salim's and Sultan Murat's mosques (Ibrahimgil and Keleş, 2018, 24). The most important engineering building is the aqueduct,





**Figure 3.** Panoramic view of Pljevlja, Hussein Pasha's Mosque with the Clock Tower in the Forefront, 2003 (Courtesy of J. Durgut).

**Figure 4.** Photo of bar from 1877 by Pietro Marubi (Photo from Bar Heritage Museum).

a stone edifice with 17 arches, 3 km long (Ivanović, 2013, 15), significant part of it still existing today.

Due to the frequent military operations, significantly-damaged Venetian tower was turned into a watch-tower, while the clock tower function was attributed to it in 1753 (Rastoder, 2000, 209-11). Since the fortification is located on the hill in the Old Town framework, the clock tower has ever since remained a significant landmark, together with the city-walls and the important buildings inside, such as the well-preserved public bath, whereas the mentioned mosques are in ruins (**Figure 5**). Suburbs outside the city-walls where the civilians lived, preserved its oriental appearance to date, while the buildings within the fortified city are gradually reconstructed as cultural-historical monuments. Bar was annexed to Montenegro following the military conquest that significantly damaged it in 1877, and in line with the Berlin Congress decision from 1878 (Rastoder, 2000, 88-9). The Old Town of Bar represents the biggest urban agglomeration in ruins in Montenegro. The New Town has been developing as a contemporary, independent urban whole at the very sea coast.

**Figure 5.** Photo of the Old Town from 2018. Encircled is the Preserved Public Bath (Hamam) (Photo by R. Alihodžić).

**Figure 6.** Gravure of Ulcinj from 1615 by Henry de Beauvau (Photo from Ulcinj Heritage Museum).

Ulcinj (Ülgün) was, as an important military fortification, seized from the Venetian Republic by the Ottoman Empire in 1571. It became part of the Vilayet of Skutari and later of the Sanjak of Skutari (Hadžibrahimović et al., 2014, 269). The fortress was turned into a contemporary, fortified complex, while its former architecture was adapted to the new functional and cultural needs of the military and residential purposes of military and civil officials (**Figure 6**). The fortress was repaired in 1697, 1718, 1790 and



in 1834. Inside the fortress, a mosque was built, as recorded in Ottoman archives, by Sultan Selim II in 1510 (Ibrahimgil and Keleş, 2018, 14 -21). Today it functions as a museum, its minaret in ruins. The water-supply and the sewage were constructed in the 18<sup>th</sup> century, while the public water fountain was built in 1749-50 (Ivanović, 2013, 98). Ottoman-period mosques that would later be destroyed were Meraja (constructed in 1779) and Meterizi (the year of construction is unknown). Existing today are these mosques: Pasha's with hamam and water fountain (1719), Ljama's (1689), Namzgjah (1728), Vrhpezar (1749), Bregut (1783) and Ibrahim-Pasha's Mosque, known as the Sailors' Mosque (1834) (Agović, 2015, 141-9). The following tomb mausoleums (türbe) are also considered important: Murat Dedej, Fanit Pulti and Resulbegovića. The clock tower was built in the newly-established neighbourhood outside the city-walls in 1754, in the vicinity of the Namazgjah Mosque (Ivanović, 2013, 99).

By the time they conceded Ulcinj to Montenegro in 1880, Ottomans had left a significant mark to the Old Town physiognomy. It has been well-preserved, reconstructed, functionally active and it considerably influences the overall cityscape (Bošković, Mijović, Kovačević, 1981, 10-1). This is, in terms of topography, also due to the dominant position of the Old Town in the wider space (Figure 7).

Ottomans annexed Podgorica (*Podgoriçe*) in 1474, during the rule of Mehmed II, after seizing the fortified town of Medun from its ruler Stefan Crnojević. During the four centuries of Ottoman rule over the wider area, Podgorica was part of the Sanjak of Scutari and later Scutary Vilayet. Following the conquest, the construction of the fortress on the confluence of Ribnica to Morača started. It was called Tepedöğen (Sancakli, 2017, 1) and it was completed with all the prominent buildings in 3-4 years (Figure 8). Inside the city-walls, Ottoman-type streets and buildings were built, yet adapted to the local climate and traditionally-used materials, stone being the dominant one (Rastoder, 2000, 1036). Fatih Sultan Mehmed's Mosque (1472-1474) was built, that would later be destroyed. In 1867, military hospital and military barracks on the opposite side of Ribnica river were constructed, as well as the ammunition warehouse inside the fortress. None of the three buildings any longer exist (Ibrahimgil and Keleş, 2018, 35-43). Apart from considerably developed urban matrix with Ottoman-style residential architecture, two mosques were built: Starodoganjska Mosque (16<sup>th</sup> century) and Osman-Pasha Mosque, built by Hajji Mehmed-



Figure 7. Old Town of Ulcinj in 2016 (Courtesy of G. Resulbegović).





**Figure 8.** The fortress at the Confluence of Ribnica into Morača River, 1870; Author: Pietro Marubi (Archives of the Institute for the Protection of Cultural Monuments of Montenegro).

**Figure 9.** The remains of the fortress at the Confluence of Ribnica into Morača River with the Preserved Bridge, Built by Hadji Mehmed-Pasha, 2016 (Courtesy of Ž. Stajkić).

Pasha Osmanagić (18<sup>th</sup> century). Both still exist today. The bridge over Ribnica is still functional today and its construction is also attributed to Hajji Mehmed-Pasha Osmanagić (18<sup>th</sup> century). Other significant buildings from the Ottoman period are the ruined mosques: Glavatovića, Hadrovića and Dračka, then the Vizier's bridge (devastated, yet still in function) and the military bath (hamam), which has been partially preserved. Adrovića, and Kapidžića bridges on Ribnica are destroyed, while Tabački bridge still exists. The clock tower was built on the market square, outside the city-walls, in the second half of the 18<sup>th</sup> century (Ivanović, 2013, 92). This part of Podgorica is nowadays called *Stara varoš*. Even today, it represents a relevant segment of the urban structure of Podgorica (Figure 9). Following the Berlin Congress decision in 1878, Podgorica was annexed to Montenegro (Jovićević, 1999, 183). Today it is the State's capital.

Ottomans conquered Herceg-Novi (Hersek) in 1482. Its urban development was based on the defence function, due to its location at the entrance of the strategically important Boka Bay. Following the crusade wars, Ottoman innovative engineering knowledge in constructing fortifications started to apply in Europe. It was implemented in Herceg-Novi upon Ottomans' arrival, through renovation of the existing and construction of some new fortifications (Ilijanić et al., 2014, 173). Until the present day remaining important urban elements, there are: a tower in the northern part of the city, called Kanlı Kule (Bloody tower, in Turkish) and a tower in the southern part, called Abaz-Pasha's tower, better-known under its Venetian name *Forte Mare*. In the eastern part of the city, Trnovica tower was built (Ilijanić et al., 2014, 174). The ruined endowments from the Ottoman period, whose year of construction is unknown, are: Ahmet-Pasha's Mosque, Mahmud-Bay's Mosque, the hamam and water-fountain by Hajji Šemsudin Ahmet-Bey (Ibrahimgil and Keleş, 2018, 11). The clock tower was, in fact, the upper city-fortification's western gate from the Ottoman period, constructed in 1667. Herceg-Novi was at the time the second biggest city in the Sanjak of Herzegovina (after Mostar) with five residential neighbourhoods. It was held by Ottomans, with minor interruptions, up until 1687 (In 1538-1539, it was under Spanish rule). After the Ottomans, the city was conquered by the Venetian Republic in 1687, to be taken over by the Austrian-Hungarian Monarchy in 1797. In the period 1813-1814, the city was ruled by the temporary Government of Montenegro and Boka Kotorska, whereas in the period 1814-1918, the city was once again administered by Austrian-Hungarians (Ivanović, 2013, 100). Herceg-Novi was annexed to the Kingdom of Serbs, Croats and Slovenes in 1918. It became an integral part of Montenegro in 1945 (Ilijanic, 2015, 153- 65).



**Figure 10.** The gravure of Herceg-Novi during the Ottoman Rule, before 1538; Author: G. Rosaccio (From Herceg-Novi archives, taken from Ilijanić, 2015, 132).

**Figure 11.** City-walls of the old town of Herceg-Novi during the Ottoman Period, the position as of 2013. Orto-Photo Description of the Cultural Asset (taken from Ilijanić, 2015, 279).

**Figure 12.** Panoramic View of Pljevlja in 1908, with Hussein-Pasha's Mosque and the Clock Tower (Photo from Pljevlja Heritage Museum).

### Pljevlja Clock Tower (16<sup>th</sup> Century)

All the works undertaken by Bosnian Beylerbeylik Beylerbeyi, Hussein-Pasha Boljanić, prepared Pljevlja in the best possible way for becoming a new seat of the Sanjak of Herzegovina in 1576 -1833, thus replacing the town of Foča (Zlatar and Pelidija, 1985, 115-29). During the rule of Hussein-Pasha Boljanić, the principal building was considered to be the semi-dome mosque bearing his name, still existing today. The original inscription that might confirm its construction date was torn away in wars. One source indicates that it was built in 1569 (Zlatar and Pelidija, 1985, 115). Another source claims that it was erected the same year as the Sinan-Bey's Mosque in Čajniče, in 1570/71. The assumption seems plausible that it was designed by Mimar Hayrüddin, architect of the famous Mostar-bridge (Andrejevic, 1978, 177-190). In the vicinity of the Hussein-Pasha's Mosque, the clock tower was built (Figure 12).

Pljevlja clock tower is one of the oldest in the Ottoman Empire, dating from the late 16<sup>th</sup> century or the early 17<sup>th</sup> century, while its meticulous elaboration, dimensions and elegance point at an affluent period of the Ottoman rule. It is assumed to be the part of Hussein-Pasha Boljanić' *waqf*, or that it was built right after the construction of Hussein-Pasha's Mosque (Petrovic, 2014, 279). Figure 13 indicates the clock tower in its present state. Pljevlja had never been a fortified city, therefore the clock tower and the mosque belonged both to the commercial neighbourhood (*çarşı*) and to the comprehensive urban tissue of Pljevlja with its wider surroundings. Even today, these buildings represent integral parts of Pljevlja's general city concept, their role of key urban cores being continuously reaffirmed.

Due to the descending terrain levelling, the plan of Pljevlja clock tower in Pljevlja extends over different heights. The ground-floor plan measures 3.60 x 3.60 m, to be reduced, due to the walls slightly narrowing upwards, to 3.25 x 3.25 m at the highest point, the overall height at the roof being 24.5 m (Figure 14). The outer walls are made of stone, 90 cm thick, thus providing for internal space at the ground level measuring 1.8 x 1.80 m, which is constant along the vertical. The tower slightly narrows towards the top, thus acquiring a dynamic appearance. Entrance is at the south-east side and is positioned at level +1.20 m, measuring 0.67 x 1.46 m. The entrance inlet is vaulted by a quadripartite vault made of ashlar stone. The door is made of timber, clad in sheet copper (Figure 15).

Up to level +18.85 m, the outer walls are made of ashlar stone particularly-dressed at the corners with a finishing cornice, entailing two rectangular mouldings and the arched one in the centre (at level +19.05 m). From level +19.05 m up to level +22.11 m, the outer walls are plastered and painted in white lime. On all the four sides, there are openings measuring 1.10 x





Figure 13. Pljevlja Clock Tower, 2018  
(Courtesy of J. Durgut).

Figure 14. The plan and the cross-section of  
Pljevlja Clock Tower, 2018 (Drawing by R.  
Alihodžić).

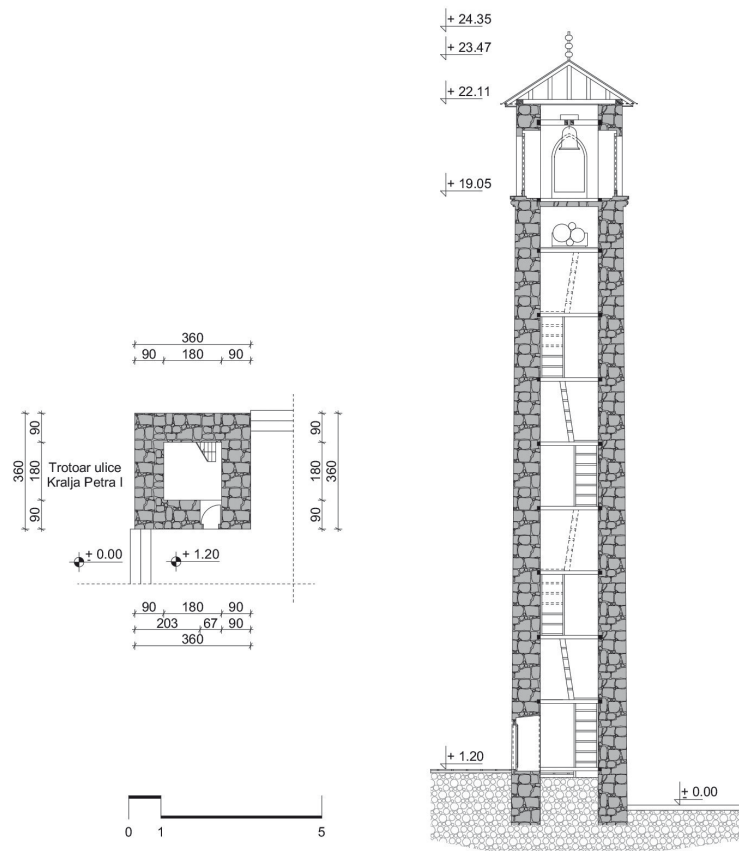

1.63 m, each finishing in a pointed arch (**Figure 16**). The ridge of the four-angled, timber roof is at level +23.47 m. Internal staircase is steep, one-armed and made of timber. There are 8 landings and 53 stairs leading to the clockwork-mechanism. Daylight reaches the staircase through the conical openings measuring 0.10 x 0.30 m, six of them on the southeast and two of them on the southwest side. The roof is clad in sheet copper instead of the original sheet lead. Alem on top of the clock tower, with three balls on the spear, is 0.98 m high, the overall height of the clock tower being 24.35 m. It is more than half the height of the Hussein-Pasha's Mosque minaret, which reaches the height of 42.0 m. The clock of the diameter 1.2 m is placed at one side only, the southwestern side. The incised inscription on the clock "Weil Harter" points at its Austrian-Hungarian origin (Agović, 2015, 90).

The first protection interventions on the tower were performed in 1974 by the Institute for the Protection of Monuments of Montenegro. In the past, the walls' authentic stone surface had at some point been covered in plaster (**Figure 17**). During the interventions, the plaster was removed in order to restore the tower's authenticity. The assumption that the wall had not originally been plastered is supported by the fact that it was made of ashlar stone with geometric finishing on the corners. Further works aimed at protecting and revitalising the clock tower were carried out in 2004. The grouting of the stone wall was completed, a new timber staircase reconstructed, new wooden windows with trims were built-in, the



**Figure 15.** The vaulted clock tower entrance and the metal door, 2018 (Courtesy of J. Durgut).



**Figure 16.** Wall-structure of the clock tower, with the cornice on top of the stone wall and openings with pointed arches, 2018 (Courtesy of J. Durgut).



**Figure 17.** Clock tower with the subsequently plastered walls, 1932 (Photo from Pljevlja Heritage Museum).

1. Document by Institute for the Protection of Cultural Monuments of Montenegro, No.01-1779/2-61, dated 22/11/1961.

**Figure 18.** Hussein-Pasha's Mosque with the clock tower, 2018 (Courtesy of J. Durgut).

**Figure 19.** The mosque and the clock tower without the surrounding walls used to be integral part of the urban tissue, 2001(Courtesy of J. Durgut).

entrance door was replaced by a new one made of timber, clad in sheet copper. Sponsor of works was Pljevlja Islamic Community, while the design documentation was elaborated by the Faculty of Civil Engineering in Podgorica (Agovic, 2015, 92).

In 2009, a stone wall was built, surrounding the mosque on the west to form a courtyard, with the permit by the Institute for the Protection of Cultural Monuments of Montenegro, although it had not existed beforehand (**Figure 18**). The remaining three sides of the wall were built in 2017. The clock tower became partially shielded by the new wall, while the mosque was closed even more, thus becoming disintegrated from the overall urban tissue (**Figure 19**). Taking into consideration its historical and architectural value, since 1961 the clock tower has been put under State's protection as an immovable cultural asset, within Hussein-Pasha's Mosque ensemble (**1**).





### Bar Clock Tower (1753)

In the fortified city of Bar, Ottomans found a significant Venetian settlement, which, beside other buildings, had a tower nearby the church (1571). The gravure in **Figure 20** (from the time the city fell under Ottoman rule) depicts the tower alongside the landscape-dominating church. Ottomans adapted it to serve as a military watch-tower. Given the seismic sensitivity of this area, it had been significantly damaged by frequent earthquakes. It had remained in that condition until 1753, when Hajji Yahya-Agha Ibrahim (Hacı Yahya Ağa Ibrahim) had it renovated, at the same location and with all the remains. He bequeathed part of his wealth for its maintenance (Rastoder, 2000, 209-11).

The 1863 photograph shows the clock tower and the mosque dominating over the densely-populated city (**Figure 20**). The fact that the clock tower was actually built over the remains of the Venetian church-tower is underpinned by different layout of openings and by different construction styles. The clock tower acquired all the Ottoman architecture features, including the octagonal roof emerging from the four-vaulted roof.

During the Montenegrin conquest of the fortress, most of the buildings were damaged. The clock tower was a particular military target since it served as a watch-tower. The first interventions on the clock tower were made in 1922, since it was a building of particular symbolic importance for the suburbs inhabitants. The walls in that period underwent renovation as they had been demolished by 2/3 of their former height. The difference is clearly visible between the old and the new wall structures, as well as their line of contact (**Figure 22**). Renovation was done in a rather improvised manner, the masons following their own notion of clock towers, while disregarding Marubi's photographs of the tower's original appearance from the Ottoman period, thus adding two semi-vaulted and one circular opening on the facade (Mijović and Milosević, 1984, 1-2). Comparison to the tower from the 1863 photograph supports this thesis (**Figure 21**).

The clock tower was again heavily damaged during the devastating earthquake in 1979. Reconstruction was carried out by the Institute for Construction of Bar in 1984 (designers were the architects Batrić Mijović and Nebojša Milošević). The design and proportional ratios were based on the photographs by Pietro Marubi from 1863 and 1877 (**Figure 4**), (**Figure 21**). Except for the state of play on the very site and the mentioned photographs, no other sources had been available to guide the reconstruction of the clock tower.

Masonry was done in ashlar stone, with cut rubble stone between ashlar blocks at the corners. The clock tower's plan measures 4.5 x 4.5 m (**Figure 24**). Given the considerable sloping of the terrain, the height of the tower

**Figure 20.** 1571 gravure fragment, showing the church tower; Author: C.F.Camutio (Photo from Bar Heritage Museum).

**Figure 21.** The old town of Bar in 1863, the clock tower was built over the church-tower remains; Author: Pietro Marubi (Photo from Bar Heritage Museum).

**Figure 22.** The clock tower in 1930s, following the 1922 interventions. (On the left wall, the line between the new and the former wall structure is clearly visible). Unknown author. (Photo from the archives of the Institute for the Protection of Monuments in Cetinje).





**Figure 23.** A fragment of the clock tower from the Marubi's 1863 Photograph (Photo is from Bar Heritage Museum).

**Figure 24.** Bar clock tower plan and cross-section, 2018 (Drawings by R. Alihodžić).

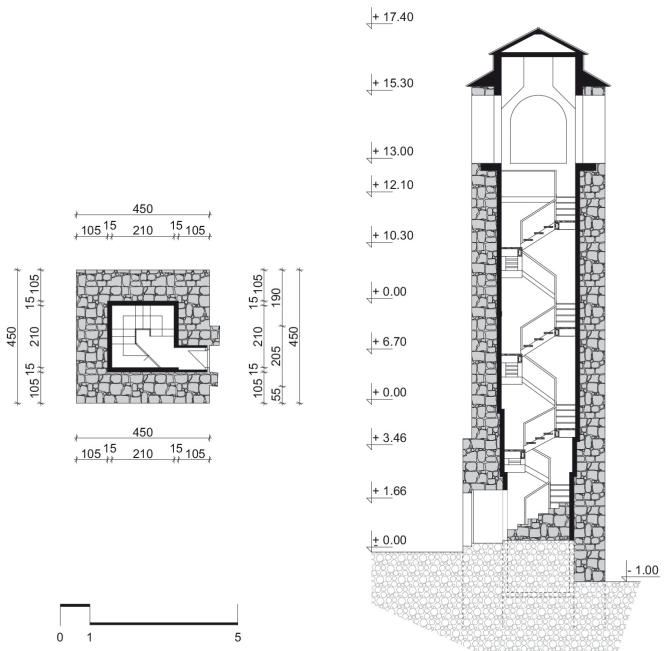

2. Document by Institute for the Protection of Cultural Monuments of Montenegro, No.1206, dated 26/11/1957.

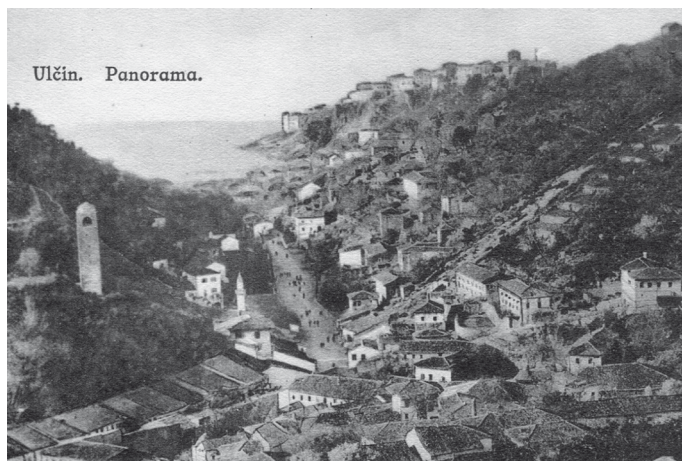

**Figure 25.** Clockwork mechanism installed in 1985. State of play in 2018 (Photo by R. Alihodžić).

varies, ranging from 17.4 m at the ground level to 18.4 m at the ridge, thus causing the proportional ratios to vary from 1:3.3 to 1:4.1. The stone walls are 1.05 m thick and they end up with a single-layer stone cornice towards the roof. From the wall height of 16.7 m (measured from level +18.4 m), the four-vaulted roof is formed, topped with curved clayed tiles. Emerging from this structure, the octagonal roof is formed from level 15.8 m. All the roof slopes are 25° with eaves measuring 0.15 m. During the 1984 intervention, the roofing was built in reinforced concrete, which could never be authentic. Either wood or stone should have been used instead. Design features of the tower have nonetheless been preserved. The tower's interior had originally measured 2.5 x 2.5 m. For the sake of structural reinforcement, a 0.15 m thick, peripheral shear wall made of reinforced concrete was built on all inner surfaces, so that now the inner space measures 2.10 x 2.10 m. Leading to the vaulted openings at level +13.0 m, there is a four-arm timber staircase with one stone and six timber landings. The width of a staircase arm is 0.80 m. The first seven stairs are made of stone. The vaulted openings measuring 2.0 x 2.3 m were built on all the four sides beneath the roof. Entrance to the tower is on the north-east, measuring 0.6 x 1.80 m, with a metal door shaped as a vertical grid. A new clock-mechanism and two dials were added, which had not existed before, since the clock functioned only by striking the bells. The dials, located at the north-east and the south-east façade, were installed there in 1985 (**Figure 25**).

Experience with earthquakes most probably influenced the tower's proportion, favouring safety over delicate structure. The building dominates over the urban tissue as its key landmark. The tower had a considerable impact on the style of clock towers in Ulcinj and Podgorica. As of 1957, it has been under State protection as an immovable cultural asset in the framework of the Old Town-walls (2). However, a major drawback of the Old Town of Bar is its exclusively museum-like, archaeological-site





**Figure 26.** The oldest available gravure of Ulcinj from 1573. Unknown author (Photo from Ulcinj Heritage Museum).

**Figure 27.** Photo of Ulcinj outside the fortress with the clock tower, 1905 Unknown author (Photo from Ulcinj Heritage Museum).

character, since there are no other activities that might contribute to its urban reconstitution.

#### **Ulcinj Clock Tower (1754)**

The most antique gravure of the fortified Ulcinj dates from 1573. By then, the Ottomans had already conquered the city (**Figure 26**). Following the conquest (1571), the construction of the walls and the buildings inside was intensified for defence purposes. The warehouses were built, storing arms, gun-powder, food and water tanks, while water-supply was constructed later. Military barracks were built, as well as houses of the fortress's commander, high civil servants and judges. (Hadžibrahimović et al., 2014, 267).

The suburbs, where most of the inhabitants lived, developed fast. Consequently, the commercial district was created, where the clock tower was built one year after the Bar clock tower construction. Its stylistic features indicate the undoubtable influence of the latter. Its construction was financed by citizens' charity contributions in 1754 (Hadžibrahimović et al., 2014, 283). It was positioned in the location above Suleiman Mualiev's Namazgjah Mosque, so that it would be visible both from the Old and the New town (**Figure 27**). From the main road, it is possible to observe this effective composition of the mosque's minaret and the clock tower, providing a significant character to the overall cityscape (**Figure 28**).

The clock tower was significantly damaged in the devastating earthquake in 1979, most of it being completely destroyed. Parts of the walls and openings were preserved to the extent of allowing for a proper reconstruction (**Figure 29**), (**Figure 30**). In 1981, Republic Institute for the Protection of the Monuments of Culture in Cetinje elaborated the design documentation, in line with which reconstruction works were carried out in 1984 (**Figure 31**). The photograph presents its current state. The foundations were fortified by reinforced-concrete construction and the anti-seismic nucleus was constructed on the inside walls, consisting of 0.10 m thick, reinforced-concrete sheets. The upper part of the tower, the roofing and the roof cover were all fully reconstructed in line with the available documentation (Mugoša and Čilikov, 1982, 4-5).

The wall is made of rubble stone in lime plaster, measuring 4.40 x 4.38 m (**Figure 32**). The stone wall is 0.94-0.96 m thick, the inner space measuring 2.43 x 2.47 m. The overall height from the ground level to the ridge is

**Figure 28.** Clock tower and Namazdjah Mosque, 2018 (Photo by R. Alihodžić).

**Figure 29.** Clock tower after the 1979 earthquake (Archives of the Institute for the Protection of Monuments, Cetinje).

**Figure 30.** Clock tower after the 1979 earthquake (Archives of the Institute for the Protection of Monuments, Cetinje).



19.35 m. Six-landing timber staircase leads to level +13.3 m. The staircase's arms are 0.70 m wide. Smaller rectangular openings between the landings provide for the lighting, four of them on the south-west façade. There is one square and two rectangular openings on the north-east façade, and one rectangular opening on the ground floor on the south-east. On all sides, arched openings, measuring 1.30 x 1.80 m, start from level +13.30 m. There is a clock beneath each of these openings, yet nowadays non-functioning. The four-vaulted roof starts from level +17 m and it ends with an emerging octagonal roof. The roofing is made of timber, topped with curved clayed tiles. The entrance is on the south-west façade, measuring 0.86 x 1.40 m, ending with a tripartite stone arch. The door is made of timber (**Figure 33**). The marble-board inscription above the relieving arch is unreadable, due to the permanent damage the letters' relief underwent over time (**Figure 34**).

**Figure 31.** Clock tower appearance in 2018 (Photo by R. Alihodžić).

**Figure 32.** Ulcinj clock tower plan and cross-section, 2018 (Drawing by R. Alihodžić).

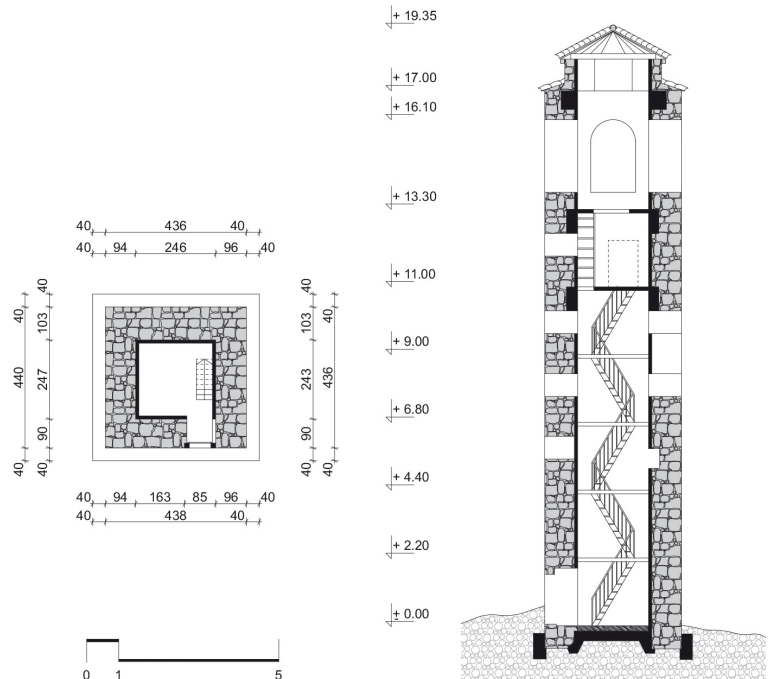





**Figure 33.** Clock tower's entrance door with a Tripartite Stone Arch, 2018 (Photo by R. Alihodžić).



**Figure 34.** Damaged inscription on the marble-board above the entrance-door is unreadable, 2018 (Photo by R. Alihodžić).

Proportional ratio of Ulcinj Clock tower is 1:4.39. Its dimensions are similar to the Bar clock tower, which proves the architectural influence of the latter. During the 1984 reconstruction, the original appearance of the clock tower was considerably preserved. It has since 1954 been under the State protection as immovable cultural asset (3).

### Podgorica Clock Tower (Second Half of the 18<sup>th</sup> Century)

The exact construction year of Podgorica clock tower has not been determined. What is known is that it was built by Hajji Mehmed-Pasha Osmanagić as one of his endowments in the second half of the 18<sup>th</sup> century, simultaneously with creation of other important edifices he endowed: Osman-Pasha Mosque and the bridge over Ribnica (Zlatičanin, 1999, 31). It was built on the outer side of the city-walls alongside the market. Its position was dominant in the urban tissue of that time, making it a landmark for most of the surroundings (**Figure 35**). Until the 1950s, it had been the

3. Document by Institute for the Protection of Cultural Monuments of Montenegro, No.183, dated 24/03/1954.

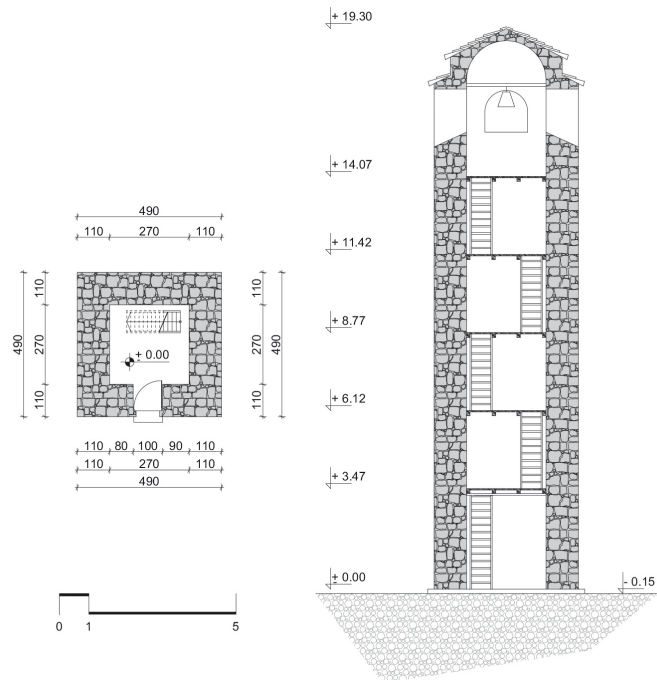

**Figure 35.** Clock tower in the 1922 urban tissue. Unknown author (From collection of A. Abdić, Podgorica).



**Figure 36.** Photo of the clock tower from 1922. Unknown author (From collection of A. Abdić, Podgorica).

**Figure 37.** Plan and cross-section of the clock-tower in Stara Varoš-Podgorica 2018 (Drawing by R. Alihodžić).



tallest building on the left bank of Ribnica (**Figure 36**). English traveller and archaeologist William Denton, during his visit to Podgorica in 1865, wrote (cited by Koprivica, 2013, 61): “When we reached the borough, the first thing that struck us was a rectangular tower. In the beginning, it seemed a church tower, for it was the tallest building in the area. Yet, once we got closer, we noticed that it was a clock tower, most probably the work of Venetians, standing there on its own as if it were a Belgian tower, or an Italian campanile”.

The clock tower square plan measures 4.90 x 4.90 m (**Figure 37**). The stone wall, dressed on corners, is 1.10 m thick, making inner space measure 2.7 x 2.7 m. Rectangular entrance door, measuring 1.0 x 2.0 m is placed on the north-east, with a flat, monolith lintel. The door is made of timber, in a rectangular stone frame. (**Figure 38**). Two-arm timber staircase lead from the ground floor at level +0.15 m up to level +14.07 m. It consists of five landings, lightened by some smaller openings on the south-west wall. Overall tower's height is 19.30 m, resulting in proportional ratio 1:3.9. Its dimensions and proportion ratio are similar to those of the Ulcinj clock tower. Four-vaulted roof starts from level 17.47 m, while the octagonal upper wall emerges from it, topped with octagonal roof (**Figure 39**). There are arched openings, measuring 1.20 x 1.20 m, on all four sides, while the windows' parapets have slanted finishing. The clock is at the south-west side. Inner side of the octagonal cube ends in a dome, for the sake of better acoustics, which is not the case with the towers in Bar and Ulcinj. Curved clayed tiles cover the roof. In a period after World War I, a metal cross was put on top of the tower, remaining there until present day.

First interventions on the clock tower were made four years after the annexation of Podgorica to Montenegro in 1892. Clockwork-mechanism was renovated, while a new bell was imported from the Italian town of Bassano, the work of a famous master Pietro Colbahini (Radunović, 2016, 10).





**Figure 38.** Clock tower's entrance door, 2018 (Photo by R. Alihodžić).



**Figure 39.** Combination of the four-vaulted and the octagonal roof, 2018 (Photo by R. Alihodžić).



**Figure 40.** Clock tower's present state after the 2017 reconstruction provided by TIKa (Photo by R. Alihodžić).

“Podgorica clock tower is repaired and the clock is in place, while the bell had already been tattered with time. The Prince provided 200 forints. Municipality had to pay 1000 forints for the tower's reparation, purchase of the clock and its installation. Surrounding it, were the market and the local inns”.

**Figure 41.** The new-design landscaped area around the clock tower, realised by TIKa. State of Play in 2018 (Courtesy of Ž. Stajkić).

No major restoration works on the clock tower occurred before 2012. It was then that the roof covering got repaired, together with the entrance door and the clock that became digitalized. The bell and the clockwork-mechanism remained. The clock tower was fully renovated in 2017, with support of Turkish Agency for Cooperation and Coordination - TIKa (Figure 40). In this process, the whole square was landscaped, with stone-slab paving, new greenery and sitting benches (Figure 41).

**Figure 42.** New buildings harm traditional cityscape- dominance of the clock tower, 2006 (Courtesy of Ž. Stajkić).

Construction of the surrounding buildings of inappropriate dimensions and style harmed the dominant position over the cityscape that the clock tower had held since the 1950s (Figure 42). However, the clock tower still remains a symbol of Podgorica's architecture and history. The clock tower





**Figure 43.** The 1667 inscription on the Gate's Eastern Façade. State of Play in 2018 (Courtesy of Zorica Čubrović)



**Figure 44.** Aquarelle by Fedor Karascay from 1837 (Fisković, 2004, 280)

has been under the State protection as immovable cultural asset since 1957, which, unfortunately, is not the case with its immediate surroundings (4).

### Herceg Novi Clock Tower (1667-1856)

East and west city gates in the Upper Town date back to the period of Ottoman rule (Mijović and Kovačević, 1975, 150). It is reasonable to claim that the west gate was built in 1667, judging by the inscription on its eastern façade (**Figure 43**), written in Arabic, its translation being (5):

“This strong tower was built by Mustafa-Agha, humble servant of Sultan’s dīwān, following the order of Sultan Mehmed. It occurred in 1078” (5).

Given the year from the inscription (1078 in Hijri Calendar refers to the year 1667 in Gregorian Calendar), it can be concluded that the order was issued by Mehmed IV, ruling in the period 1648-1687 (Čubrović, 2009, 50). Consequently, the tower was constructed during the reconstruction of one part of city-walls, following the 1667 earthquake, while the Ottoman period city-walls had been formed in 1551 (Hrabak, 1985, 83).

For a long time, the upper, octagonal part of the clock tower was considered to originate from the Ottoman period, the thesis supported even by some scientific articles. One of the proofs that the octagonal part of the clock tower was added on top of the western gate at a later stage is the aquarelle by Austrian colonel Fedor Karascay, where the octagonal, jagged part of the tower is non-existent (Fisković, 2004, 240). The aquarelle shows the arched door opening on the western gate, with the two windows above (**Figure 44**).

The fact that the clock tower was built-over at a later stage is underpinned by the request of Herceg-Novi Administration, addressed to the Military Authority-Administration over fortifications in Kotor in 1856, claiming approval to construct a city-clock above the western gate. The same documentation also includes permission issued by the Military Authority in Kotor (AHN, OH 198/1856 cited in Čubrović, 2009, 51). The fact that additional changes to the original, Ottoman-period ambience were made is underpinned by the 1914 photograph, showing the original cobble-stone at the slanted ramp (**Figure 45**). This pathway was replaced by a staircase before WWII, still existing today (**Figure 46**). The original, two-wing door was removed in that period, too (Čubrović, 2009, 52). The clock tower was damaged in the 1979 earthquake, so that extensive restauration works had to be carried out. In 2007, Regional Institute for the Protection of Cultural Monuments elaborated the restauration design of the city clock tower. Works at the clock tower finished in 2008, while the works on the part of the edifice dating from the Ottoman period were completed later (Ilijanić, 2015, 259).

4. Document by Institute for the Protection of Cultural Monuments of Montenegro, No.1232, dated 27/11/1957

5. Year 1078 in Hijri Calendar refers to the year 1667 in Gregorian Calendar. The inscription was read in 2007 by Bahija Zlatar, director of the Oriental Institute in Sarajevo, from the photograph she received (Čubrović, 2009, 50).





**Figure 45.** 1914 Photo. Cobblestone on the slanted ramp leading to the gate (Herceg Novi Heritage Museum)

**Figure 46.** Slanted cobblestone-ramp was replaced by the staircase, 2006 (Photo by R. Alihodžić)

The part of the tower built during the Ottoman period has dimensions of 4.70 x 7.20 m. There is a vaulted passage in the middle, with arched openings on both sides. It was discovered that the former semi-circular vault through the tower was removed and replaced by a brickwork semi-circular vault, having the same features and shape as the clock tower masonry. The later added part of the tower is a two storey high building. Overall clock tower height (including the Ottoman-period section), measured from the lower, eastern side is 13.33 m. Height of the arched vault is 4.83 m (**Figure 47**). The octagonal tower is an example of eclectic architecture. It is an octagonal, multi-storey building, ending with a flat roof surrounded by parapet wall enriched with dentils, similar in design to the cornice on the fortress walls. The parapet wall with dentils has a wider base than the tower, for it is supported by a set of ornamented corbels, protruding from the façade. Angles of the walls are accentuated with shallow pilaster strips, inter-connected by semi-circular arcades. The plinth of the edifice is mildly pointed out with respect to the wall. The end-result is its changed appearance, similar to a watch-tower.

Two double-arched windows with a pointed, “bulbous arch”, each containing two arched openings, are placed centrally on east and west side. Above each of them, placed in a circular, shallow niche, there is a clock. At the clock’s level, there is an arched opening on both right and left from each double-arched window, so four of them in total. It can be concluded that there was intention of linking its construction style with the Ottoman one. During the drilling research, parts of the original, stone arch with an Ottoman motive were found (**Figure 48**). This is one more crucial proof about the west gate’s Ottoman origin (Ćubrović, 2009, 55).

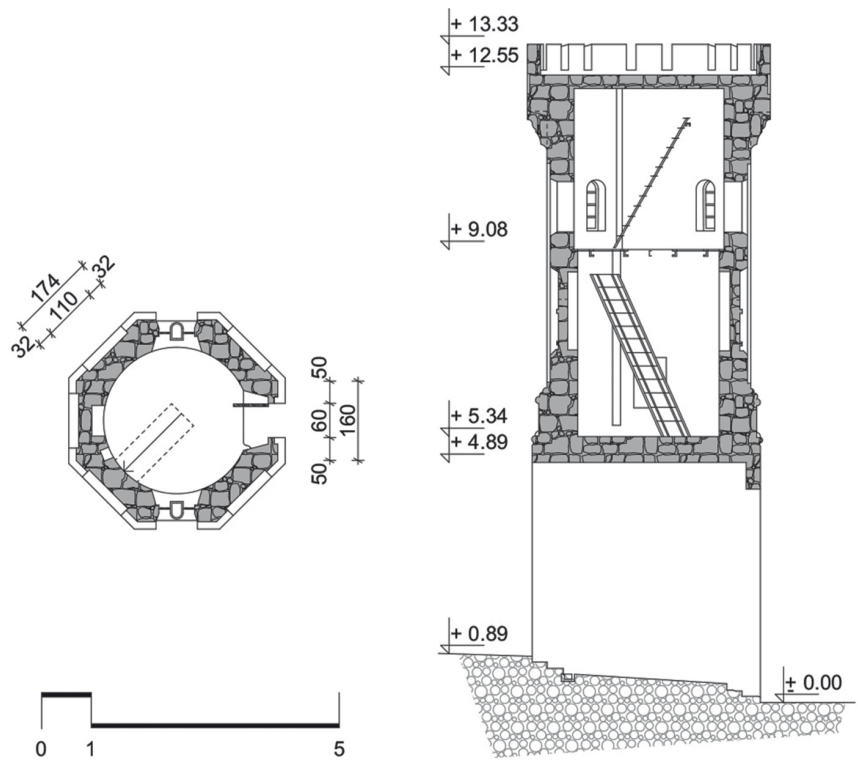

Figure 47. Herceg-Novi Clock tower plan and cross-section, 2018 (Drawing by R. Alihodžić).



Figure 48. The original Ottoman-Period lintel (Courtesy of Z.Čubrović).

6. Document by Institute for the Protection of Cultural Monuments of Montenegro, No 08-839/1, dated 1/09/1966.

The clock tower represents one of the most significant city landmarks, gravitating towards city fortifications and the main square outside the city-walls. As immovable cultural asset within the protected city fortress, the clock tower has been under State protection since 1966 (6).



### COMPARATIVE ANALYSIS OF THE PRESENTED CLOCK TOWERS

The table includes all the above examined Ottoman-period clock towers. They have been divided in three groups according to their stylistic features, elaborated both in the text above and in the table with proportional ratios. Notwithstanding this categorisation based on their construction-style, used materials, as well as local, material and historical conditions surrounding them, what they all have in common are clear and distinguishable Ottoman-architecture features.

Pljevlja Clock tower is the oldest of them, with strikingly elegant proportions and elaborate details, as a consequence of better material and social status of Pljevlja in that epoch. Graciously-thin appearance of the tower is due to the walls narrowing towards the top, demonstrating the refined knowledge and mind-set of its constructors with respect to its positioning near Hussein-Pasha's Mosque. With its pointed, arched openings below the four-vaulted roof, it represents an exceptional example of Ottoman architecture in the Balkans. Quality of its walls is enviable, while introduction of white plaster above the ornamented cornice, provides a significant aesthetic contribution. Such approach in design of introducing another material in the last segment below the roof is also visible in the clock towers in Mostar, Nevesinje, Sarajevo. It is also present in some places in Turkey: Safranbolu (Karabük), Zile (Tokat), as well as in today's Bulgaria: Blagoevgrad, Plovdiv, Botevgrad.

Clock towers in Bar, Ulcinj and Podgorica belong to the same stylistic group. Their key features are: a rectangular, robust cube with stone masonry and semi-circular openings below the roof, as well as two-section roof composition: a four-vaulted and an octagonal roof. Octagonal roof segment emerging from a four-vaulted roof is inherent to the Ottoman architecture, as well as arched openings, placed on all four sides below the roof, which were frequently seen in clock towers across the Empire's territory. There is an undoubtable influence of Bar clock tower over those built in Ulcinj and Podgorica. Use of stone in all the three towers is in line with local construction techniques. Their proportional characteristics are similar, entailing the ratio 1:3, 3-4, 39. It can be concluded that safety in seismic-sensitive areas prevailed over the graciousness, given the high seismic risk of the terrain, which was proved right by the history. Clock towers of similar features can also be seen in cities of Bosnia and Herzegovina: Maglaj, Nevesinje, Počitelj, Stolac, Tešanj.

Herceg-Novi clock tower emanates Ottoman-architecture characteristics in its primarily constructed part, while the added section on top of the western gate, originating from the Austrian-Hungarian period, is eclectic in style. The influence of the former architecture is evident to the point of

Place of construction	Time of construction	Plan dimensions in metres	Height in metres	Proportional ratio
Pljevlja	1569-1700	3.60 x 3.60	22.47-23.47	1:6.8-1:6.5
Bar	1753	4.50 x 4.50	14.80-18.50	1:3.3-1:4.1
Ulcinj	1754	4.40 x 4.40	19.35	1:4.39
Podgorica	1750-1800	4.90 x 4.90	19.30	1:3.9
Herceg-Novi	1667-1856	4.70 x 7.20	12.44-13.33	1:1.7-1:1.84

Table 1. Overview of key characteristics of the analysed clock towers.

inspiring the construction of the octagonal tower ending in cornice with dentils, leaving the impression of a watch-tower.

## CONCLUSION

The study has provided for not only a comprehensive research on all the clock towers in the today's Montenegro, but also a comprehensive analysis on the overall social-historical context demonstrating a strong presence of Ottoman culture in all segments of life. This was particularly the case with the urban structure of the cities and their architecture, which even today to a great extent provides a recognisable distinctiveness to many cities in this territory. The research has shown that the clock towers in the territory of today's Montenegro are among the most significant cultural heritage exemplars, not only from the Ottoman period, but as a whole.

Clockwork-mechanism clock towers first appeared in the western Europe, whose vicinity to the Balkans influenced appearance of the first clock towers in the western part of the Ottoman Empire: in Osijek (present-day Croatia), then in Banja Luka (present-day Bosnia and Herzegovina). Shortly after the construction of Banja Luka clock tower, the one in Pljevlja was built. Consequently, not only do these buildings bear importance for the Montenegrin culture, but for the overall culture of the Ottoman Empire. New facts that have been established by this study complement the knowledge on this type of buildings.

Comparative analysis has shown that there is a considerable number of clock towers in a relatively small Montenegrin territory. They belong to three stylistically-different groups, demonstrating the variety of local construction and historical influences when embracing Ottoman architecture.

Pljevlja Clock tower is graciously-thin, of exceptional proportions. It is among the oldest and the most beautiful clock towers in the Ottoman Empire. It appeared earlier compared to many important Ottoman Empire centres, which proves that the territory of present-day Montenegro significantly participated in important courses of civilisations within the Ottoman Empire, benefiting both from the East and from the West. In the collective memory, the clock tower is strongly associated with foundation of Pljevlja, its development and the most important events in history, which had always been very turbulent in this area. Nonetheless, the clock tower and Hussein-Pasha's Mosque have overcome those challenges thanks to their impressive historical-aesthetic status. In terms of style, the clock tower belongs to the Ottoman-period buildings, with four pointed arches on the white, finishing segment of the tower with ornamented cornice.

Clock towers in Ulcinj, Podgorica and Pljevlja are located in the living urban tissue of their respective cities, thus continuing to be a significant element of urban development and cityscape. They are permanent inspiration to the artists, through music, painting, poetry. They witnessed many historical events and anecdotes, thus becoming a striking element of the collective memory. Bar clock tower is the integral part of internal urban structure of the Old Town, inside which there is no active life, with the exception of few religious buildings, rendering the role of the clock tower limited in the new urban tissue. However, it persists as an important spatial element, located in a dominant position over the city.



Herceg-Novi Clock tower is significant for its lower section belonging to the original western gate of the Ottoman-period fortification. Part of the clock tower, constructed over the western gate had been attributed to the Ottoman period, due to its double-arched windows with pointed arches. It was established that the part of the tower with the clockwork-mechanism was built in 1856, during the Austrian-Hungarian rule. Due to its position, the clock tower significantly participates in forming the cityscape and the main city-square, adjacent to the fortress-wall. Architectural features of the corpus with the clock were matched with the Ottoman architecture, so that the overall picture of the Ottoman-period fortress was not distorted. On the contrary, it gained significance.

Beside the undoubtable Ottoman influence on the construction of clock tower in Montenegro, some of their specificities were identified compared to others in the Ottoman Empire, in particular regarding those in Bar, Ulcinj and Podgorica. Construction of these was strongly influenced by local constructors, domestic masons who applied significant elements of Ottoman architecture, reflected in robust forms, application of octagonal roof-endings emerging from the four-vaulted roofs, with the arched windows below. Octagonal roof endings approximate the form of a cone, the element normally used in mosque-minarets, and similar solutions are present in many Ottoman buildings with a hidden dome. These clock towers are examples of symbiosis of local construction styles, application of materials inherent to the location (stone, in this case) and new culture of construction that was imported by the travelling architects from the Ottoman Empire. They possess, notwithstanding the minimalist design approach, a distinguished stylistic expression.

Given their functional character, attractiveness, authenticity and spatial position, they, even today, represent important urban landmarks. They have become a public asset with strong symbolic meaning, providing their respective locations with authenticity that influences cityscape memory, as well as with a recognisable historical-civilizational layer inherent to the Ottoman Empire in this territory. These arguments lead to identifying a multi-cultural image of Montenegro, as a proof of how important has been the impact of great civilisations. Montenegro is highly-conscientious about the significance of clock towers, so that they have been renovated and put under State protection as immovable cultural asset of paramount importance.

#### BIBLIOGRAPHY

- ACUN, H. (2011) *Osmanlı İmparatorluğu Saat Kuleleri*, Atatürk Kültür Merkezi, Ankara.
- AGOVIĆ, B. (2015) *Turbeta i Sahat Kule u Crnoj Gori*, Almanah, Podgorica.
- ANDREJEVIĆ, A. (1978) *Pljevaljska Džamija i Njeno Mjesto u Islamskoj Umjetnosti na Našem Tlu*, Seoski dani Sretena Vukosavljevića, Prijepolje.
- BORSTIN, D. (1983) *The Discoverers, A History of Man's Search To Know His World and Himself*, Division of Random House, New York.
- BOŠKOVIĆ, Đ., MIJOVIĆ, P., KOVAČEVIĆ, M. (1981) *Ulcinj I*, Institut za Arheologiju, Beograd.

- ČUBROVIĆ, Z. (2009) *Istraživanje Kule Gradskog Sata u Herceg Novom*, Boka 28-29, Zbornik radova iz nauke , kulture i umjetnosti. JU gradska biblioteka i čitaonica, Herceg Novi.
- ČUBROVIĆ, Z. (2018) Figure 48. The Original Ottoman-Period Lintel. Private Archives of Z. Čubrović.
- DENTON, W. (1937) *Nekoliko Dana u Crnoj Gori*, Obod, Cetinje.
- FISKOVIĆ, C. (2004) *Spomenička Baština u Boki*, Matica Hrvatska, Zagreb.
- GENERALIĆ RADOJIČIĆ, D. (2009) *Graditeljsko Nasljeđe Opštine Herceg Novi*, Arhitektonski Fakultet, Podgorica.
- HADŽIBRAHIMOVIĆ, M., DEMIROĞLLU, N., KILIBARDA, N., JAHIĆ, M., HAFIZ, N., ZUBČEVIĆ, T., TODOROSKA, K., PETKOVSKA, N., INBASI, M., ÇELIK, B. TEMIZER, A., GLUŠČEVIĆ, V., KOVAČEVIĆ, V., MINOV, N., PEROVIĆ, S., JOVOVIĆ, V., PULEVIĆ, V., DŽOGOVIĆ, A., EFE, R., SÖNMEZ, S., SOYKAN, A., CÜREBAL, I., ORUC, H., KURPEJOVIĆ, A., QERETI, D. (2014) *100 Godina od Odlaska Osmanlija sa Balkana (Knjiga III)*, Almanah, Podgorica.
- HRABAK, B. (1985) *Turske Gradnje i Dogradnje u Fortifikacijama Herceg Novog*, Boka 17, Zbornik radova iz nauke , kulture i umjetnosti. JU gradska biblioteka i čitaonica, Herceg=Novi.
- IBRAHIMGIL, M.Z., KELEŞ, H (2018) Osmanlijski Vakufi (Zadužbine) u Crnoj Gori Power Point Presentation Yunus Emre Enstitüsü, Podgoritsa, Scientific Pannel "Osmanlijska arhitektura na Balkanu" held on 27 February 2018, Univerzitet Crne Gore . Podgorica .
- ILIJANIĆ, B., PELIDIJA, E., KÖKSAL, E., GUŠTIN, M., KOŽAR, A., ORUĆ, H., KUJOVIĆ, D., PAJOVIĆ, R., ARSLAN, I., ŠABOVIĆ-KEROVIĆ, I., KADUMOVIĆ, L., VULIĆ, S., DIZDAREVIĆ, F., AGOVIĆ, B., ŠABOTIĆ, S., HAJDARPAŠIĆ, S., RADOMAN, A. PREMOVIĆ, M. (2014) *100 Godina od Odlaska Osmanlija sa Balkana. Knjiga II*, Almanah, Podgorica.
- ILIJANIĆ, B. (2015) *Herceg Novi Grad i Graditeljsko Nasleđe*, Ilibo Design Architect, Herceg Novi.
- IVANOVIĆ, Z. (2013) *Urbani Razvoj Gradova Crne Gore u Turskoj Imperiji*. Geografski institut Filozofskog fakulteta, Nikšić.
- JOVIĆEVIĆ, A. (1999) *Zeta i Lješkopolje*, CID, Podgorica.
- KARAČ, Z. ŽUNIĆ, A. (2018) *Islamic Architecture and Art in Croatia*, Faculty of Architecture, University of Zagreb.
- KUJOVIĆ, D. (2006) *Tragovima Orijentalno-Islamskog Kulturnog Nasljeđa u Crnoj Gori*, Almanah, Podgorica.
- KOPRIVICA, T. (2013) *Britanska Arheološka Misija na Duklji 1893*, Društvo za Izučavanje Starina MNEMOSINA, Podgorica.
- MARKOVIĆ, Č., VUJIČIĆ, R. (1997) *Spomenici Kulture Crne Gore*, Republički zavod za zaštitu spomenika kulture, Cetinje.
- MIJOVIĆ, B., MILOŠEVIĆ, N. (1984) *Sahat Kula Bar; Projekat Sanacije i Rekonstrukcije*, ZIB, Bar.
- MIJOVIĆ, P., KOVAČEVIĆ, M. (1975) *Gradovi i Utvrđenja u Crnoj Gori*, Arheološki institut , Beograd – Muzej, Ulcinj.



- MILJKOVIĆ, E., PREKIĆ, A., ŠERBO, R., PELIDIJA, E., ZLATAR, B., MIOVIĆ, V., BEŠLIJA, S., TASLIDŽA, F., DACIĆ, N., MAHMUTOVIĆ, M., BANOVIĆ, B., DURGUT, J., KUJOVIĆ, D., ABDIJEVIĆ, L. (2019) *Husein Paša Boljanić i Njegove Zadužbine*, Islamska zajednica u Crnoj Gori, MINS, Nikšić.
- MUGOŠA, Đ., ČILIKOV, S. (1982) *Sanacija i Revitalizacija Sahat Kule u Ulcinju* (projektna dokumentacija), Republički Zavod za Zaštitu Spomenika Kulture, Cetinje.
- PETROVIĆ, M. (2014) *Pljevlja u Kraljevini Crnoj Gori, I Svjetskom Ratu i Jugoslovenskoj Državi 1913-1941*, AP Print, Podgorica.
- PREKIĆ, A., ŠERBO, R., PELIDIJA, E., ZLATAR, B., MILJKOVIĆ, E., MIOVIĆ, V., BEŠLIJA, S., TASLIDŽA, F., DACIĆ, N., MAHMUTOVIĆ, M., BANOVIĆ, B., DURGUT, J., KUJOVIĆ, D., ABDIJEVIĆ, L. (2019) *Husein Paša Boljanić i Njegove Zadužbine*, Islamska zajednica u Crnoj Gori, MINS, Nikšić.
- RASTODER, Š., ANDRIJAŠEVIĆ, Ž., PAPOVIĆ, D., FOLIĆ, Z., ŠABOTIĆ, S., DROBNJAK, S., SELHANOVIĆ, S., DRINČIĆ, Ž., PREKIĆ, A. (2000) *Istorijski leksikon Crne Gore A-Crn*, Daily Press, Podgorica.
- RASTODER, Š., ANDRIJAŠEVIĆ, Ž., PAPOVIĆ, D., FOLIĆ, Z., ŠABOTIĆ, S., DROBNJAK, S., SELHANOVIĆ, S., DRINČIĆ, Ž., PREKIĆ, A. (2000) *Istorijski leksikon Crne Gore Per-Ž*, Daily Press Podgorica.
- RASTODER, Š. (2000) *Vakufnama Jahje-Age Ibrahimova iz 1753, o Sahat Kuli u Starom Baru*, Almanah, Podgorica.
- RADUNOVIĆ, M. (2016) *Konzervatorski Projekat Sahat Kule u Podgorici*, Muzeji i Galerije, Podgorica.
- SANCAKLI, N. (2017) *Bosnakmedya*. [<https://www.bosnakmedya.com/osmanlilarin-kurdugu-karadag-bosnak-sehirler/>] Access Date (06/07/2019).
- STANOJEVIĆ, G. (1976) *Crna Gora*, Naša Knjiga, Beograd.
- STATISTICAL OFFICE OF MONTENEGRO (2011) *Census of Population and Households*. [<https://www.monstat.org/eng/page.php?id=393&pageid=57>]. Access Date (05/05/2019).
- ŠABOVIĆ-KEROVIĆ, I. (2015) *Graditeljsko Nasljeđe Ulcinja-Između Teorije i Prakse*. Fondacija za Spomenike i Lokaltete Crne Gore „Elartt“, Podgorica.
- VASIĆ, M. (1975) *Istorija Crne GIII/1.Gradovi pod Turskom Vlašću* [, Redakcija za Istoriju Crne Gore, Titograd.
- ZLATAR, B., PELIDIJA, E. (1985) *Prilog Kulturnoj Istoriji Pljevalja Osmanskog Perioda – Zadužbine Husein Paše Boljanića, Prilozi za Orijentalnu Filologiju*. vol. 34. Univerzitet u Sarajevu-Orijentalni Institut, Sarajevo
- ZLATIČANIN, I. (1999) *Hronike*, Kulturno-Prosvjetna Zajednica, Podgorica.

#### ABBREVIATIONS

- TIKA Turkish Agency for Cooperation and Coordination  
AHN Archives of Herceg-Novi

Alındı: 01.04.2018 ; Son Metin: 30.09.2019

**Anahtar Sözcükler:** Saat kuleleri; Karadağ; Osmanlı dönemi; Kültürel miras; Kentsel odaklar.

## **BUGÜNKÜ KARADAĞ TOPRAKLARINDA OSMANLI DÖNEMİNDEN KALAN SAAT KULELERİ**

Bu makale, Osmanlı döneminde Karadağ topraklarında (1496-1912) inşa edilen saat kulelerinin çözümlemesini yaparak, bu yapıların önemine ilişkin bütüncül bir çerçeve çizmeye çalışmaktadır. Bu konu bazı geçmiş çalışma ve araştırmalar bulunmakla birlikte, bütüncül ve kapsamlı bir araştırma şimdiye kadar yapılmamıştır. Karadağ'ın da içinde yer aldığı bölgeye saat kuleleri, Osmanlı İmparatorluğunun daha gelişmiş bölgelerine göre daha erken dönemde gelmiştir. Bölgedeki saat kuleleri, yerel nitelikleri yanı sıra, Osmanlı mimarisinin güçlü işaretlerini ve etkilerini de taşımaktadır. Makale, Pljevlja (1465-1912), Bar (1571-1877), Ulcinj (1571-1880), Podgorica (1474-1878) ve Herceg Novi (1482-1687) şehirlerindeki saat kulelerini, belirtilen dönemlerde incelemektedir. Pljevlja şehri Karadağ'ın kuzeyinde; Bar ve Ulcinj ise güneyde, Adriyatik kıyılarındadır. Podgorica ise ülkenin merkezinde bulunurken, Herceg Novi ise ülkenin batısında, Hırvatistan-Karadağ sınırında bulunur.

Araştırma, saat kulelerinin inşa edildikleri toplumsal ve tarihsel bağlama odaklanmakta ve ele alınan şehirlerdeki en önemli Osmanlı yapılarına değinmektedir. Saat kulelerinin özel tarihi ve mimari nitelikleri yanı sıra, kulelerin biçimsel özellikleri belirtilmekte ve mimarlarına dair detaylı açıklamalar verilmektedir. Karşılaştırmalı analizler kapsamında, kulelere ilişkin çizimler, gravürler, arşiv belgeleri ve mevcut fotoğraflar ve dokümanlarla desteklenen değerlendirmeler yapılmaktadır. Araştırma sonuçları, ele alınan konuya dair mevcut bilgileri sistematize edip sunması yanı sıra, Karadağ'da yer alan Osmanlı kültürel mirasına ilişkin hem veri sağlamakta hem de bu alana katkı sunmaktadır. Çalışmada ele alınan her bir saat kulesi günümüzde de mevcut olup, bulunduğu şehrin önemli kentsel odağı olması yanı sıra, şehirlerin daha geniş kentsel resminin bir parçasını oluşturmaktadır. Restore edilmiş olan bu yapılar, ulusal önem taşıdıkları için taşınmaz kültür varlıkları olarak korunmaktadır.

## **CLOCK TOWERS FROM THE OTTOMAN PERIOD IN THE TERRITORY OF TODAY'S MONTENEGRO**

The study provides a research about all the clock towers built in today's Montenegro territory during the Ottoman period (1496-1912), with the aim of making a holistic image of their importance. Although previous research on the topic are available, a complex and a thorough examination of this topic has not been undertaken so far. The clock towers in this territory appeared rather early compared to the more developed areas of the Ottoman Empire. Besides the local architectonic features, they reflect a strong influence of the Ottoman architecture. This paper examines the clock towers in cities that used to be under Ottoman rule for a period of time: Pljevlja (1465-1912), Bar (1571-1877), Ulcinj (1571-1880), Podgorica (1474-1878) and Herceg-Novı (1482-1687). Pljevlja is situated in the north of Montenegro, Bar and Ulcinj are south, at the Adriatic Sea, while Podgorica is in the central part of the country. Herceg-Novı is situated on the west side of the Adriatic coast, bordering with Croatia.

The paper examines the social-historic context in which the clock towers appeared. Besides their specific history and architectural characteristics, their stylistic features have been described and their architects have been scrutinised. A comparative analysis of clock towers was made and a three-dimensional recording was presented, underpinned by drawings, gravures,



as well as archived and present-day photo-documentation. Research results have been systematised and presented, thus providing contribution not only to the cultural heritage of Montenegro, but also of the former Ottoman Empire territory. All the presented clock towers still exist today, representing significant urban landmarks in their respective cityscapes, and as such, are protected as immovable cultural property of the State.

**RIFAT ALIHODŽIĆ**; B.Arch, MSc., PhD

Received his bachelor's degree in architecture from Belgrade University and earned his PhD degree in architecture from University of Novi Sad. His theoretical research involve perceptive architectural process connected to Gestalt Psychology, as well as Montenegrin cultural heritage architecture. He is also engaged in practical architecture and urban design professionally.  
rifata@ac.me

